

Инструкция по сборке Instructions for assembling furniture Instrukcja montażu mebli

Набор мебели для Collection Kolecja mebli
общей комнаты «MONAKO»

Тумба 3D3S
Sideboard 3D3S
Komoda 3D3S

AH-028.07.00.00

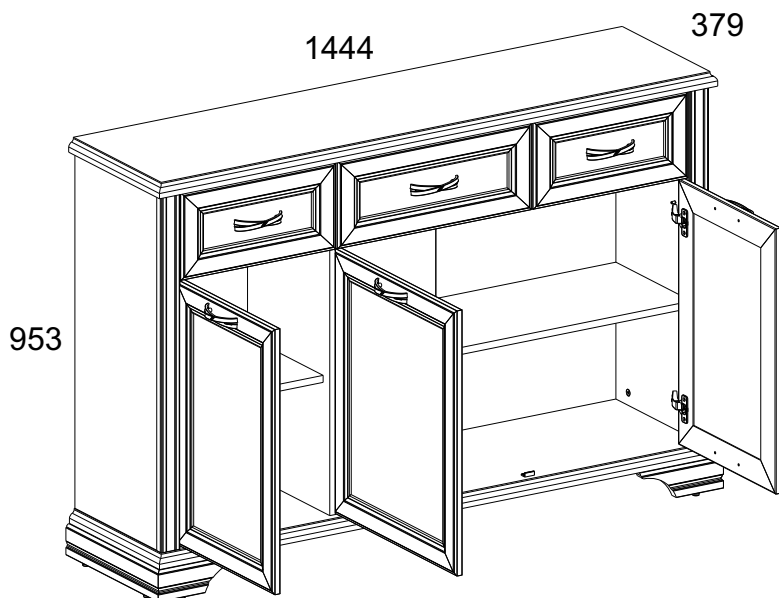

Дата изготовления
Production date
Data produkcji

Штамп ОТК
Stamp of Quality Department
Pieczęć Działu Jakości

ИООО « АНРЭКС »
Республика Беларусь, 224004
г.Брест, ул. Катин Бор, 119
тел/факс (+375 162) 30-17-07



EAЭС №BY/112 11.01. TP025 018.01 01538
от 29.12.2022
по 28.12.2027

Инструкция по эксплуатации.

Качество и комплектность изделия рекомендуется проверять в магазине при покупке в распакованном виде. Сборка изделия должна производиться в порядке, изложенном в настоящей инструкции. В процессе эксплуатации изделий необходимо периодически затягивать ослабленные винтовые соединения. В случае необходимости перемещения изделия по квартире перед его перестановкой, необходимо полностью освободить его от груза (матраца). Во избежание поломки имеющихся опор передвигание производить приподнимая изделие над уровнем пола. Запрещён прямой контакт с водой. Удаление пыли с изделий следует производить слегка влажной мягкой салфеткой. Во избежание коробления деталей и изменения цвета изделия следует избегать установки мебели на прямых солнечных лучах.

При эксплуатации изделий набора **ЗАПРЕЩАЕТСЯ:**

- устанавливать мебель вблизи отопительных приборов и вплотную к сырým стенам и в помещениях с относительной влажностью более 70%;
- температура нагрева элементов мебели не должна превышать +40 °С.
- в процессе сборки и эксплуатации изделий набора становиться ногами на горизонтальные щиты и витрины;
- применять химические чистящие средства для уборки мебели;

Гарантии изготовителя.

1. Гарантийный срок эксплуатации изделия - 24 месяца со дня продажи магазином. В период гарантийного срока изготовитель гарантирует ремонт изделий или их замену, если потребителем не нарушены правила эксплуатации.
2. Претензии предъявляются потребителем непосредственно в торгующую организацию, в которой была приобретена мебель, предъявив настоящую "Инструкцию по сборке" и копию товарного чека.
3. Изделие **Тумба 3D3S**, входящее в состав набора мебели для общей комнаты **«МОНАКО»**, соответствует требованиям ГОСТ 16371-2014, ТР ТС 025/2012.
4. Срок службы мебели - 5 лет.
5. Предприятие-изготовитель оставляет за собой право вносить изменения в конструкцию изделия, не ухудшая его конструктивные и эксплуатационные характеристики.
6. Для сборки изделий рекомендуется привлекать квалифицированных специалистов.

Запах.

От новой мебели может исходить запах материалов, из которых она изготовлена. Запах может сохраняться в течение трёх недель с момента сборки. Для снижения интенсивности запаха рекомендуется:

- для мягкой мебели - пропылесосить изделие и проветрить помещение.

Повторять 3-4 раза в день.

- для корпусной мебели – протирать тканью, смоченной мягким моющим средством, вытирать чистой сухой тканью и проветривать помещение, предварительно открывая все двери и ящики изделия.

Повторять 3-4 раза в день.

Важно! Сохраните, пожалуйста, инструкцию в случае повторной сборки мебели или рекламации. В случае составления рекламации пользуйтесь, пожалуйста, обозначением из инструкции сборки.

PL

Przy eksploatacji mebli zabrania się:

- ustawiać meble w pobliżu grzewczych przyrządów i obok wilgotnych ścian, a także w pomieszczeniach ze względną wilgotnością więcej niż 70%;
- temperatura nagrzewania elementów mebli nie może przekraczać +40°C;
- w trakcie montażu i eksploatacji mebli stawać nogami na poziome panele i witryny;
- stosować chemiczne środki czyszczące do sprzątania mebli;
- nie należy narażać na kontakt z wodą.

Gwarancje producenta.

1. Gwarancyjny termin eksploatacji wyrobu - 24 miesiące z dnia sprzedaży. W okresie gwarancyjnego terminu producent gwarantuje naprawę wyrobów lub ich zamianę, jeżeli reguły eksploatacji nie zostały naruszone przez nabywcę.
2. Roszczenia są przekazywane przez nabywcę bezpośrednio do handlującej organizacji, w której były nabyte meble, tylko przy okazaniu danej "Instrukcji montażu" wraz z dokumentem zakupu.
3. Wyrób **Komoda 3D3S**, wchodzące w zestaw mebli „**MONAKO**”, odpowiada wymaganiom Norm Państwowych 16371-2014, TP TC 025/2012
4. Trwałość użytkowa mebli - 5 lat.
5. Firma-producent pozostawia za sobą prawo do wprowadzania zmian w konstrukcje wyrobów, nie pogarszając ich konstruktywne i eksploatacyjne charakterystyki.
6. Do montażu wyrobów zaleca się skorzystanie z pomocy wykwalifikowanych specjalistów.

Zapach.

Nowe meble mogą wydzielać zapach materiałów, z których są wykonane. Zapach może utrzymywać się do trzech tygodni od momentu montażu. Aby zmniejszyć intensywność zapachu, zaleca się:

- w przypadku mebli tapicerowanych - odkurzyć produkt i przewietrzyć pomieszczenie. Powtarzaj 3-4 razy dziennie.
- dla mebli szafkowych - przetrzyj ściereczką zwilżoną łagodnym detergentem, przetrzyj czystą, suchą ściereczką i przewietrz pomieszczenie, uprzednio otwierając wszystkie drzwi i szuflady produktu. Powtarzaj 3-4 razy dziennie.

Ważne! Proszę zachować instrukcję w razie ponownego montażu mebli lub reklamacji. Podczas składania reklamacji prosimy o korzystanie z oznaczeń z instrukcji.

EN

Instruction manual.

It's advised to check the quality and completeness of the product in the store when buying unpacked. Assembling of the product should be done the way it's described in this manual. While the product is in service loose screw connections should be periodically tightened. If it's necessary to move items around the apartment before moving you should release the product completely from the load (the mattress). To prevent damage to existing supports the product should be lifted before moving. Furniture should not be exposed to contact with water. Dusting the product should be done with a slightly damp soft cloth. To prevent warping of parts and discoloration of products do not install furniture in direct sunlight.

While the product is in service it's PROHIBITED TO:

- Install furniture near heating devices, close to the raw walls and in rooms with a relative humidity of more than 70%;
- heat elements of furniture to the temperature higher +40°C;
- step on the horizontal shields and windows during assembly and use of the products set;
- use chemical cleaners for cleaning furniture;

Manufacturer's warranty.

1. The warranty period of use of the product - 24 months from the date of sale. During the warranty period the manufacturer guarantees repair or replacement of products, if the user has not violated operating rules.
2. Claims should be made by the consumer directly to the trading organization, in which furniture was purchased, presenting the "Instruction manual" and a copy of the sales receipt.
3. The product **Sideboard 3D3S**, which is part of a set of "**MONAKO**", meet the requirements of GOST 16371-2014, TR TS 025/2012.
4. The lifetime of furniture - 5 years.
5. The manufacturer reserves the right to make changes in product design, without compromising its design and application requirements.
6. To assemble the products it's recommended to attract qualified personnel.

Smell.

New furniture may emit the smell of the materials from which it is made. The smell can persist for up to three weeks from the time of assembly. To reduce odor intensity, it is recommended:

- for upholstered furniture - vacuum the product and ventilate the room. Repeat 3-4 times a day.
- for cabinet furniture - wipe with a cloth dampened in a mild detergent, wipe with a clean, dry cloth and ventilate the room, previously opening all doors and drawers of the product. Repeat 3-4 times a day.

It is important! Keep the instruction in case of reassembly of furniture or complaint. When making a claim use the notation from the instruction.

№ п/п	Длина мм.	Ширина мм.	Толщина мм.	Кол-во шт.	№ пачки
15	1426	370	32	1	3/4
33	1426	367	32	1	3/4
76	423	310	16	1	1/4
77	923	310	16	1	3/4
91	815	335	16	1	1/4
92	815	335	16	1	1/4
124	220	335	16	1	3/4
143	815	335	16	1	1/4
148	200	335	16	1	1/4
149	200	335	16	1	1/4
158	496	200	19	1	4/4
166	396	200	19	2	4/4
176	320	100	16	3	3/4
177	320	100	16	3	3/4
186	426	100	16	1	3/4
196	326	100	16	2	3/4
206	606	496	19	1	4/4
208	606	396	19	2	4/4
241	376	210	70	1	2/4
242	376	210	70	1	2/4
250	100	86	16	1	3/4
290	815	50	19	1	4/4
291	815	50	19	1	4/4
316	456	325	2,5	1	3/4
321	356	325	2,5	2	3/4
341	857	446	2,5	1	4/4
359	857	946	2,5	1	4/4

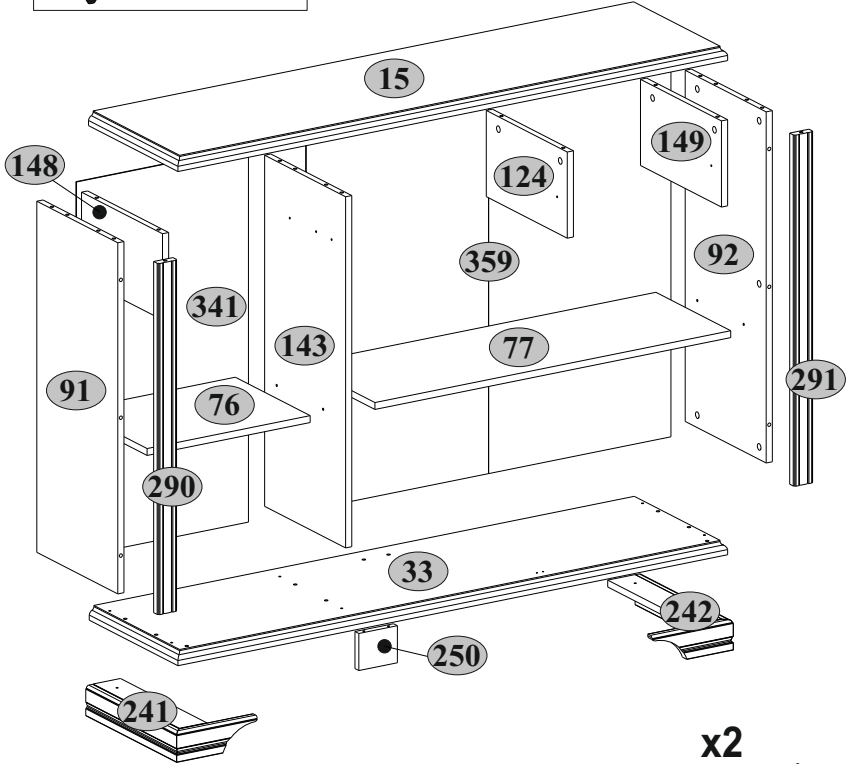
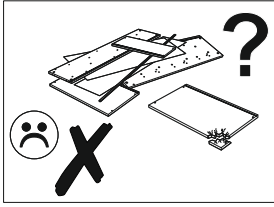



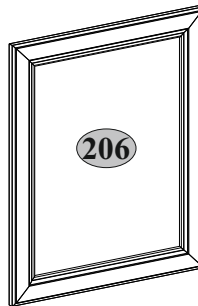
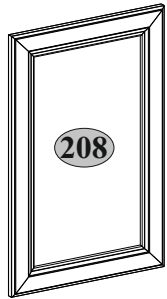



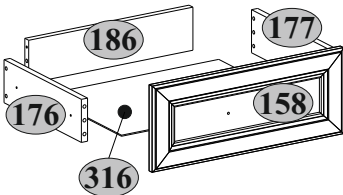
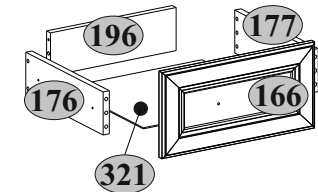

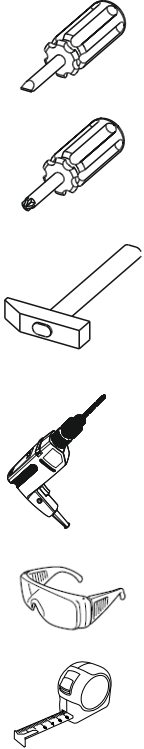



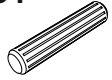
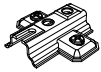
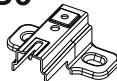







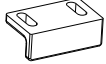

x2

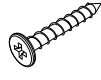

x2





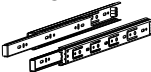

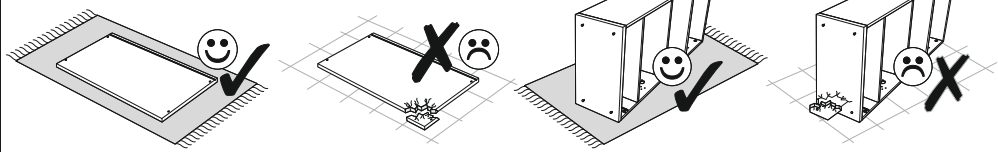
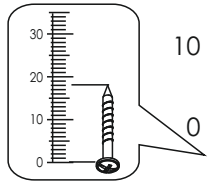
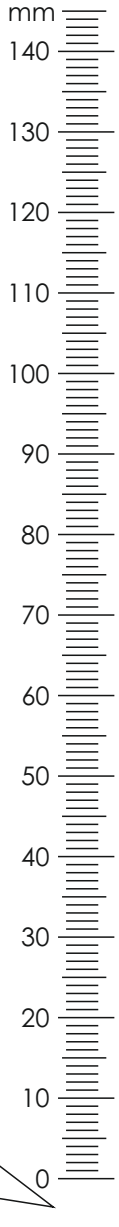
A1.0  5x28 32	A2  Ø15x13 32	C1  8x35 32	D1  2
D3  4	E2-1  4	E4  2	G  1,5x26 30
H22  6	I  S4 1	M1  M4x12 6	M12  M4x25 6
N1  7	P1  Ø5 8	Q  1,5x7 6	Q4  1
R3  3x20 28	R10  4x30 4	R23  6,3x13 12	R24  7x50 14
R27  5,0x13 30	R102  3,5x16 14	S3  4	S5  Ø18 20
S9  Ø12 2	Z10  300 3		



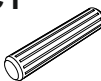

1

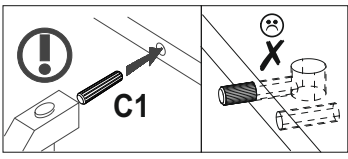
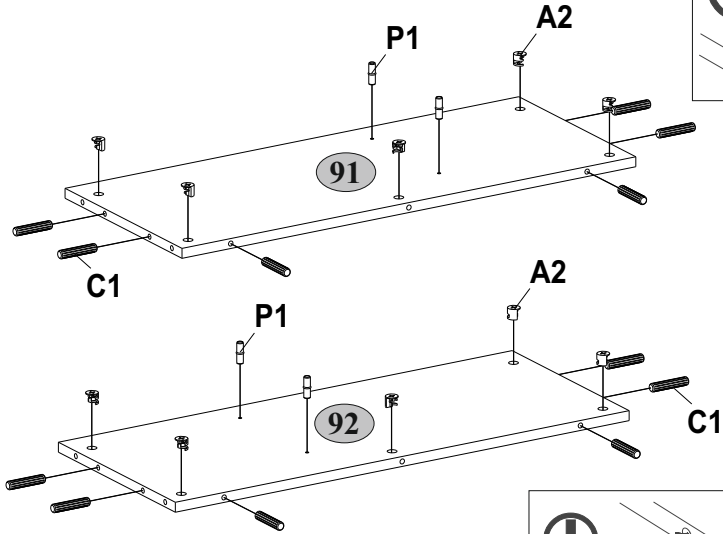
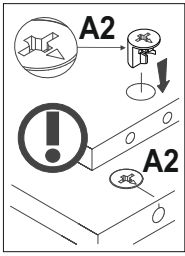
A2  Ø15x13 10	C1  8x35 12	P1  Ø5 4
---	---	--

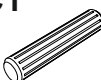

2

A1.0  5x28 2	C1  8x35 4	D3  4	R23  6,3x13 8
---	---	--	--

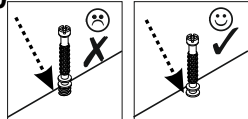
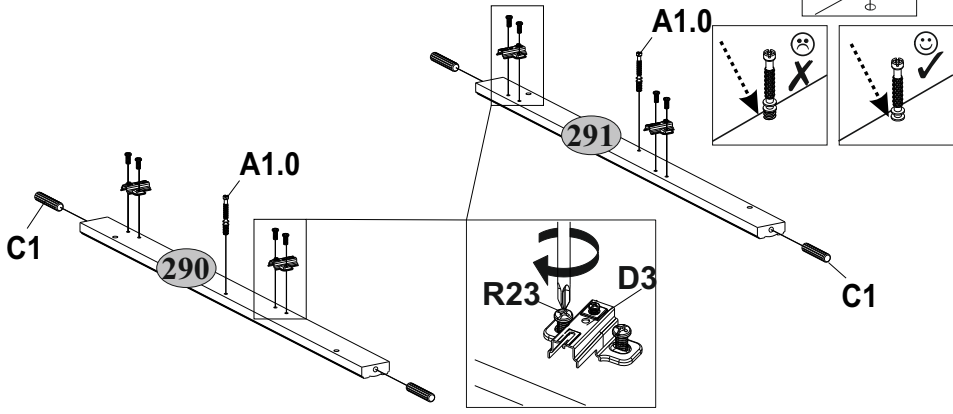
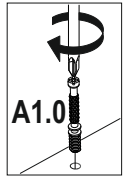

3

A2



∅15x13

R27



6 5,0x13

Z10

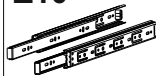

12 300

2

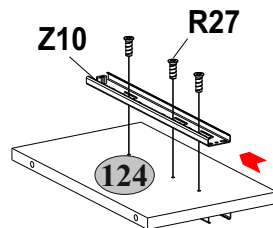
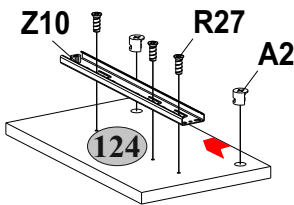
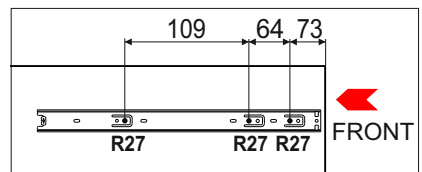
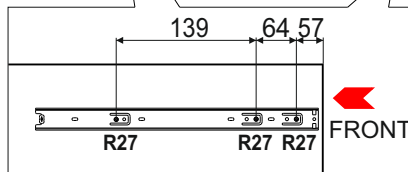
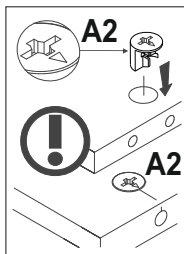
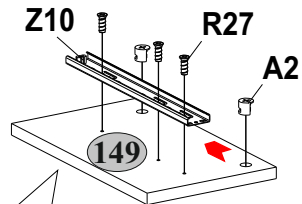
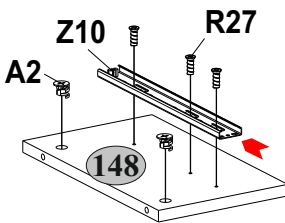
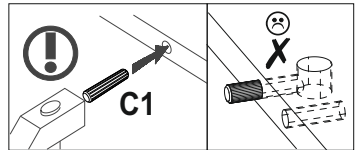
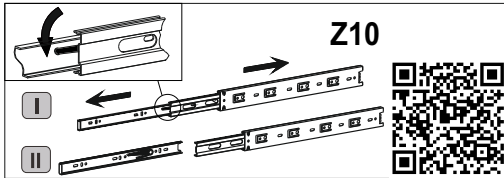

4

A2



∅15x13

4

C1

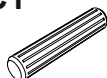

8x35

4

D1

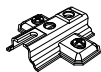

2

P1



∅5

4

R23



6,3x13

4

R27



5,0x13

Z10

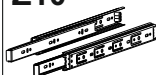

6

300

1

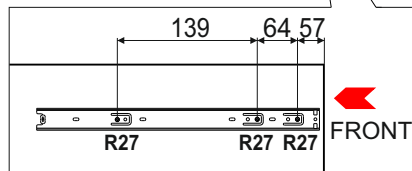
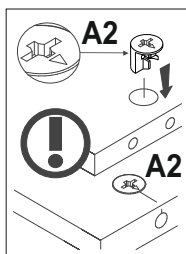
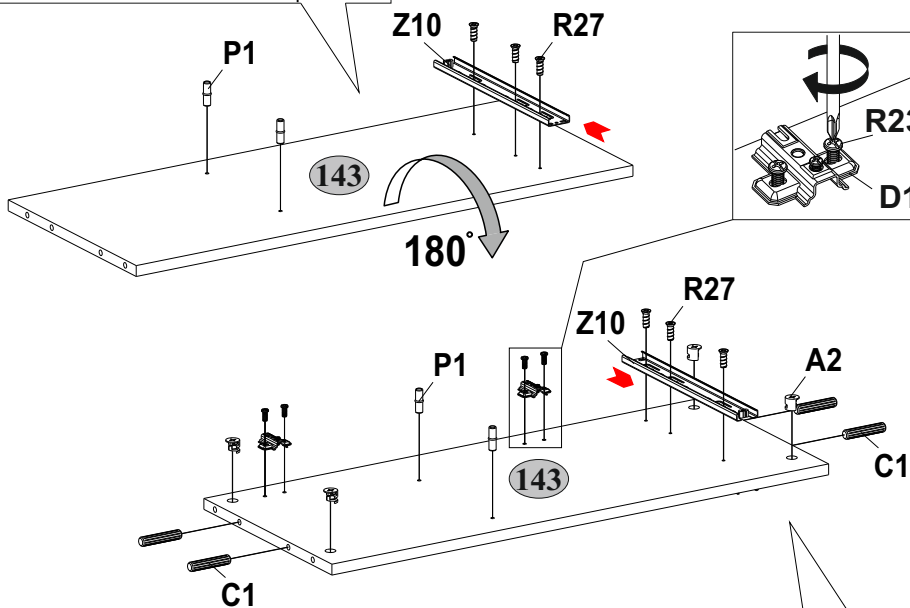
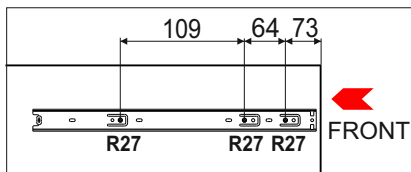
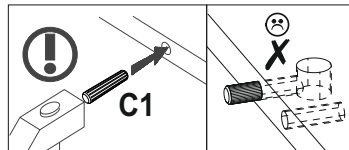

5

A1.0



5x28

6

Q4

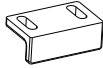

1

R102



3,5x16

2

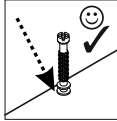
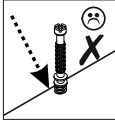
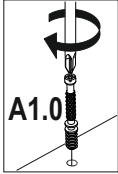

A1.0

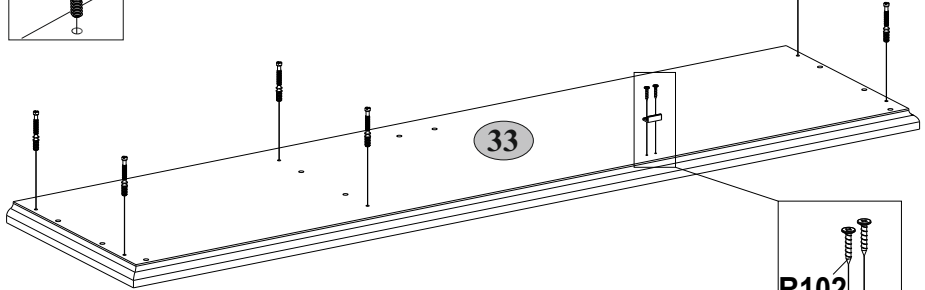

R102

Q4

6



N1

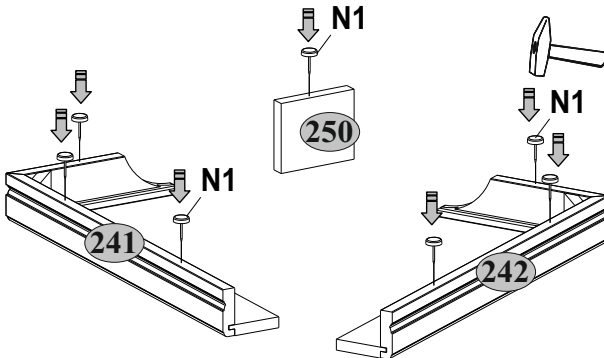

7



7

I 	R10 	R24 
S4 1	4x30 4	7x50 2

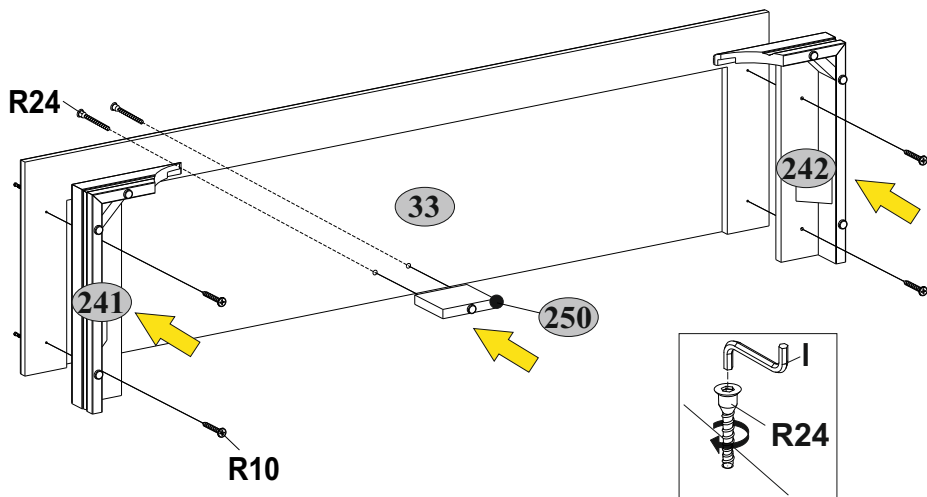

8

A1.0 
5x28 12

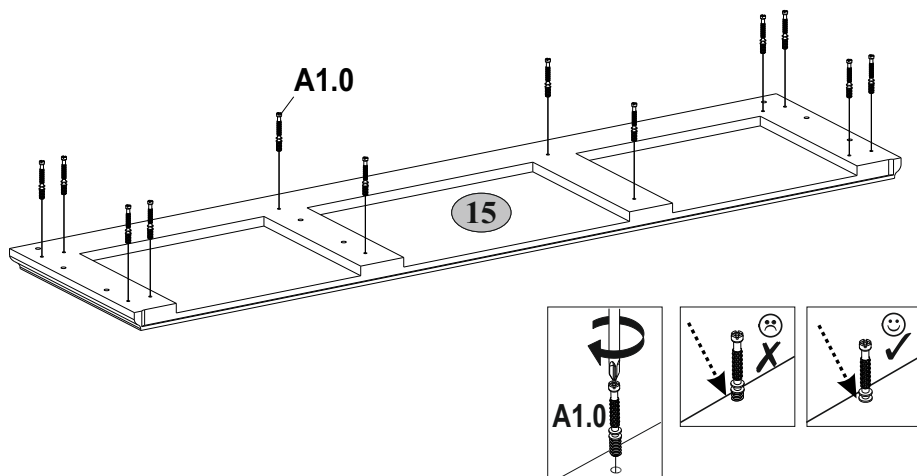

9

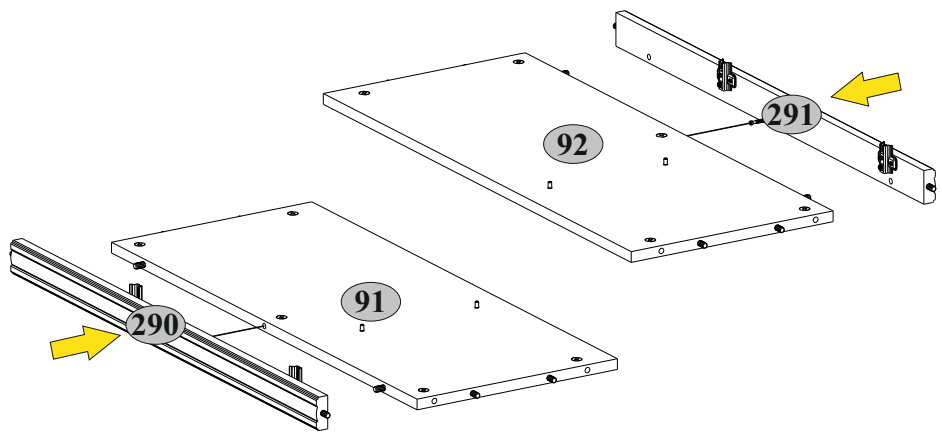
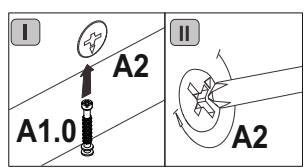

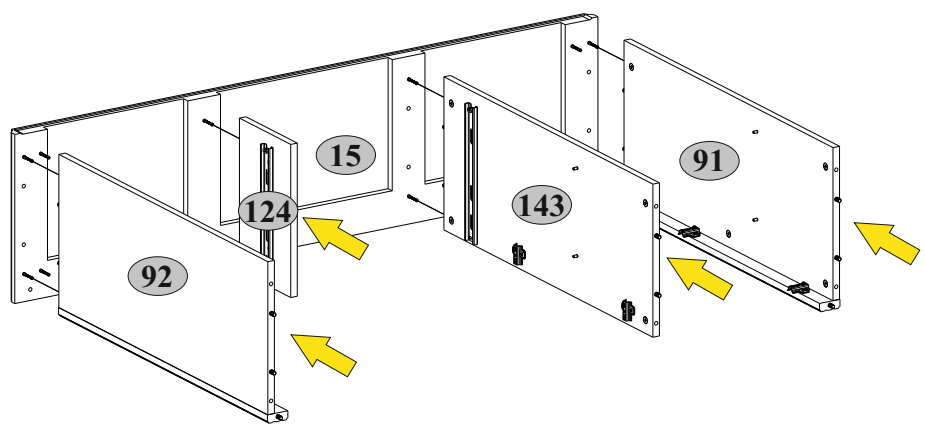
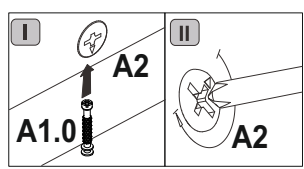

10

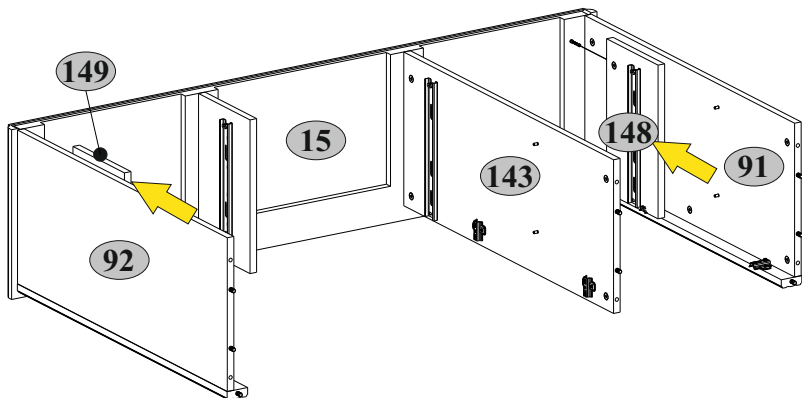
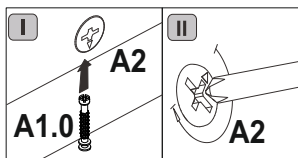
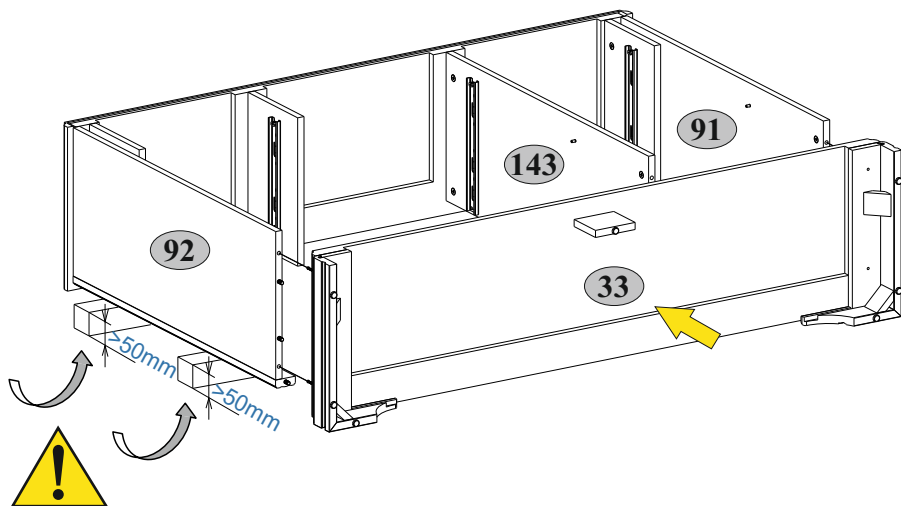
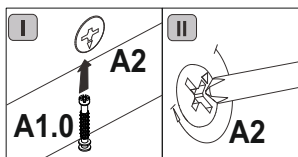





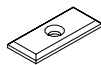

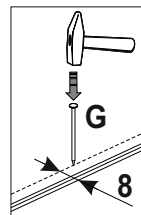
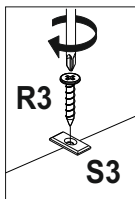
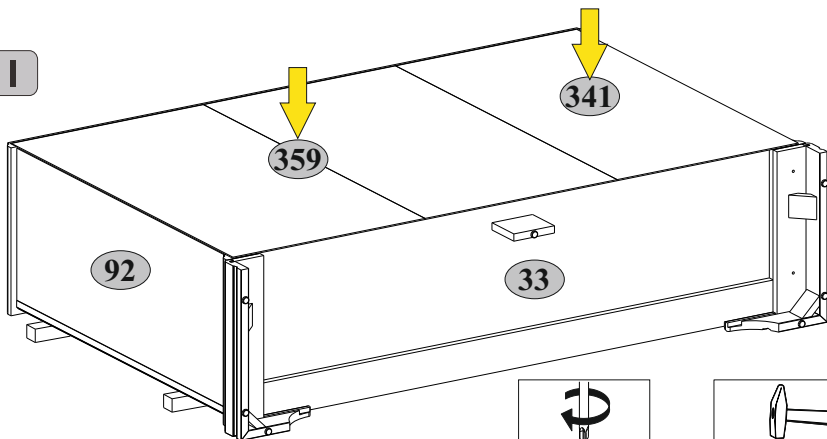
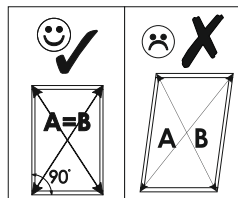
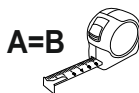
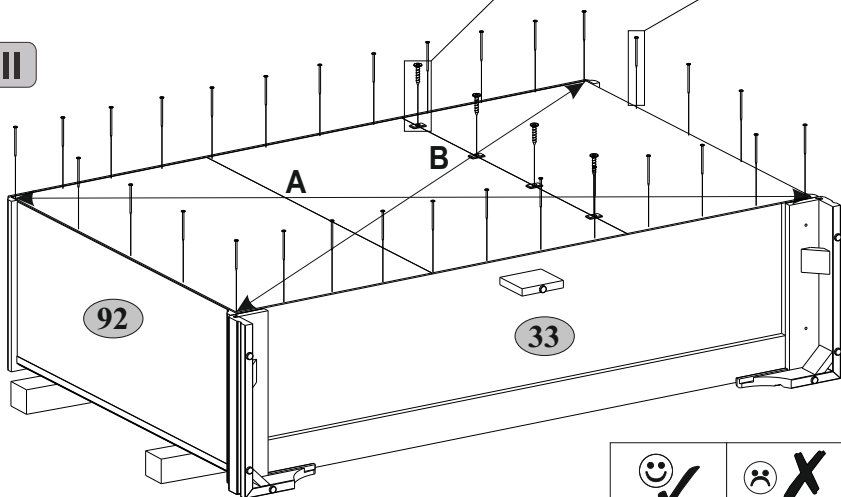

11**12**

13

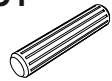
G  1,5x26 30	R3  3x20 4	S3  4
---	---	---

I**II**

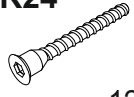
14

A1.0  5x28 12	A2  Ø15x13 12	C1  8x35 12	H22  3
I  S4 1	M1  M4x12 6	R24  7x50 12	R27  5,0x13 12

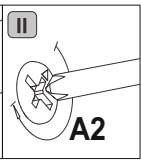
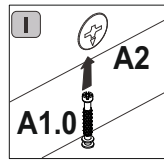
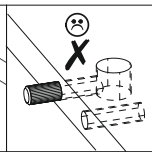
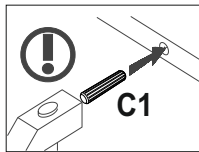
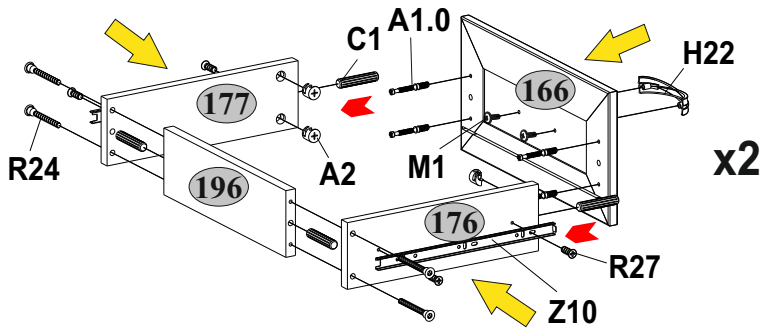
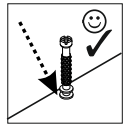
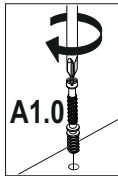
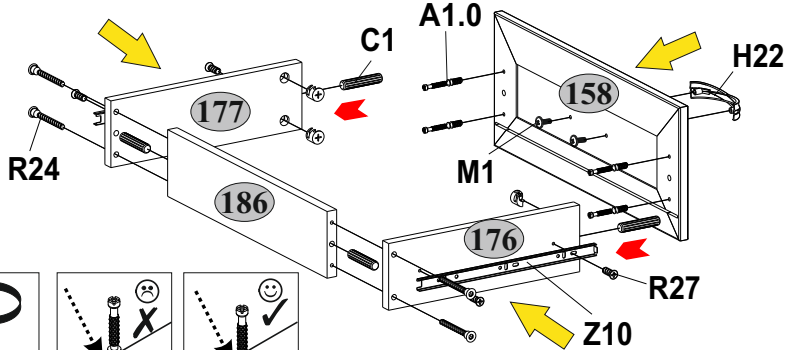
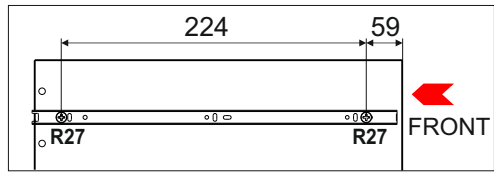
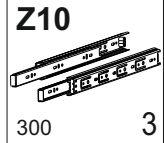
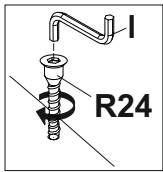
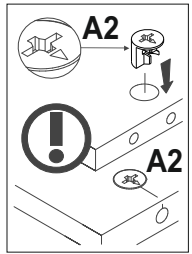

15**R3**

3x20

24

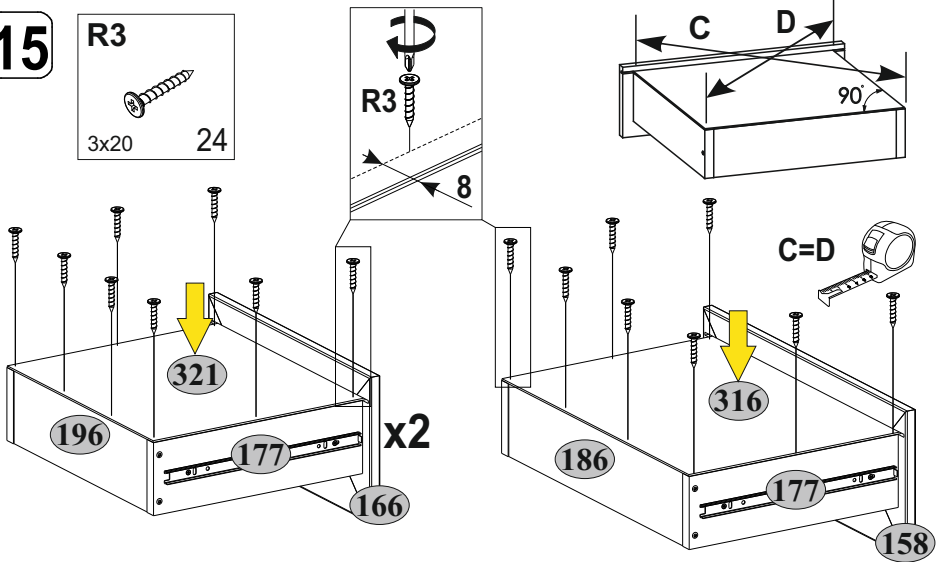
**16****E4**

2

H22

1

M12

M4x25

R102



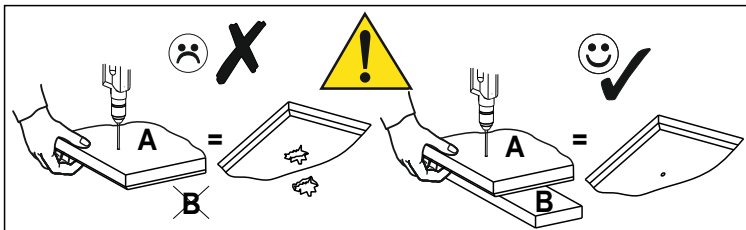
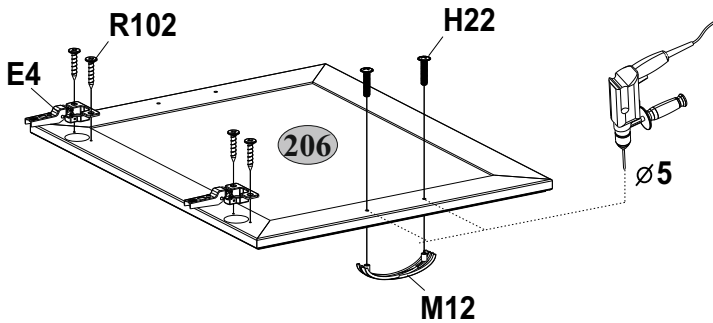

2

3,5x16

4



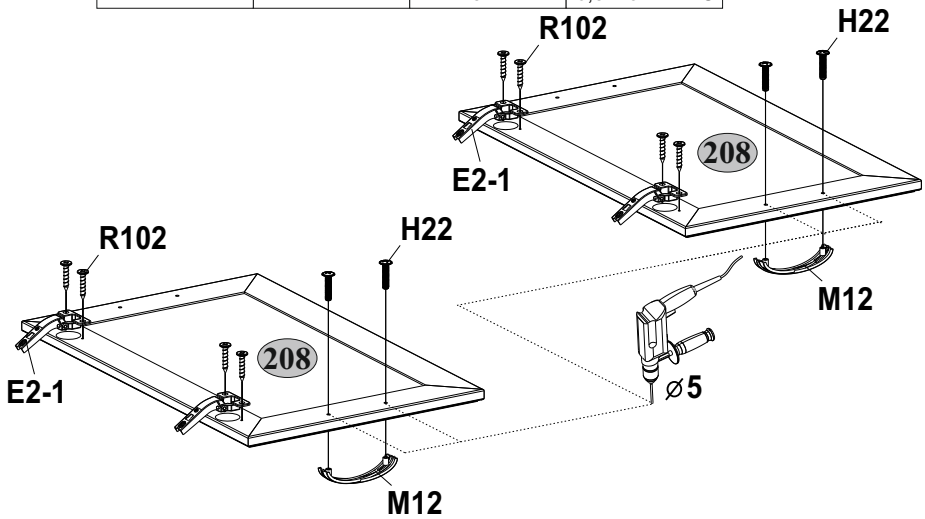

17

E2-1  4	H22  2	M12  4 M4x25	R102  8 3,5x16
---	--	--	--



18

Q  1,5x7	S5  6 Ø18	S9  20 Ø12	2
--	---	--	----------

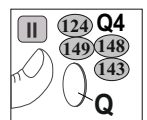
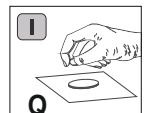
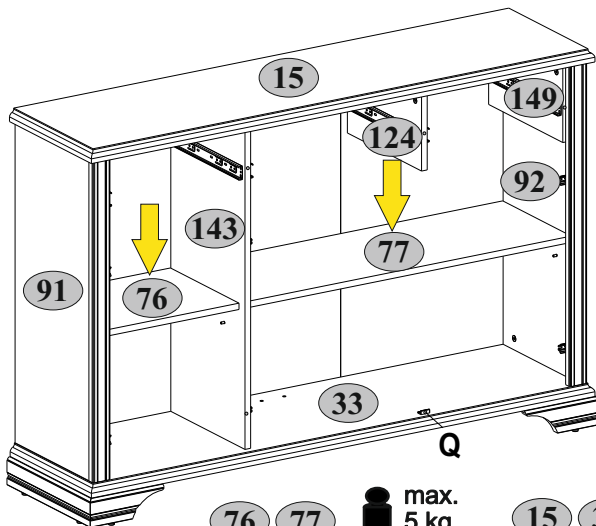
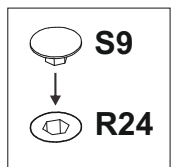
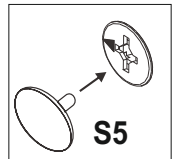

76 77  max. 5 kg
 15 33  max. 20 kg

19

